

# Dell™ DLT, VS and SDLT Media Handbook

**Version 2.3**

**Last Modified 10/10/05**

Information in this document is subject to change without notice.

© 2005 Dell Inc. All rights reserved.

Reproduction in any manner whatsoever without the written permission of Dell Inc. is strictly forbidden.

Trademarks used in this text: *Dell*, the *DELL* logo, *PowerEdge*, and *PowerVault* are trademarks of Dell Inc.; *Post-it* is a registered trademark of 3M. *Windows* is a registered trademark of Microsoft Corporation.

Other trademarks and trade names may be used in this document to refer to either the entities claiming the marks and names or their products. Dell Inc. disclaims any proprietary interest in trademarks and trade names other than its own.



---

# Table of Contents

<b>List of Tables</b> .....	<b>4</b>
<b>List of Figures</b> .....	<b>5</b>
<b>1 Revisions and Ownership Information</b> .....	<b>6</b>
Revision History .....	6
<b>2 Introduction</b> .....	<b>7</b>
<b>3 Drives and Media</b> .....	<b>8</b>
Reusing Type IV Media Formatted by DLT7000 or DLT8000 in VS80/DLT1 Drives .....	9
DLT1 and VS80 Drives .....	9
VS160 Drives.....	9
SDLT320 and SDLT220 Drives.....	9
<b>4 Cleaning Considerations</b> .....	<b>11</b>
Exhausted Cleaning Media.....	12
<b>5 Media Handling</b> .....	<b>13</b>
Media Care Guidelines .....	15
Proper Media Labeling Techniques.....	16
Visual Media Inspection .....	17
DLTIV Cartridge Damage Examples .....	20
SDLT Media .....	21
Cartridge Storage Conditions .....	22
Media Do's and Do Not's.....	23

---

## List of Tables

Table 1 DLT Drive Types and Basic Characteristics .....	8
Table 2 Primary Media Type per Drive.....	8
Table 3 Type IV, VS1, and SDLT1 Media Read/Write Compatibility .....	10
Table 4 Cleaning Media Compatibility .....	11
Table 5 Symptoms of Using Expired Cleaning Media.....	12

---

# List of Figures

Figure 1 DLT1 .....	8
Figure 2 VS80 .....	8
Figure 3 VS160 .....	8
Figure 4 SDLT220 .....	8
Figure 5 SDLT320 .....	8
Figure 6 Type IV Media .....	8
Figure 7 VS1 Media.....	8
Figure 8 SDLT Media.....	8
Figure 9 Cleaning Tape III.....	11
Figure 10 DLT/VS Cleaning Tape.....	11
Figure 11 VS160 Cleaning Tape .....	11
Figure 12 SDLT Cleaning Tape.....	11
Figure 13. Type IV Media Cartridge .....	13
Figure 14 Write Protect Tab .....	14
Figure 15 VS1 Write Protect Tab .....	14
Figure 16 Media Care .....	15
Figure 17 Proper Label Placement.....	16
Figure 18 Proper Barcode Placement .....	16
Figure 19 Media Inspection 1 .....	17
Figure 20 Media Inspection 2 .....	18
Figure 21 Media Inspection 3 .....	18
Figure 22 Media Inspection 4 .....	18
Figure 23 SDLT Leader Latch.....	19
Figure 24 DLT Type IV Leader Loop .....	19
Figure 25 Missing Cartridge Leader.....	20
Figure 26 Broken Leader Loop.....	20
Figure 27 Loosely Packed Media .....	20
Figure 28 Creased Leader Loop.....	20
Figure 29 Good SDLT Leader Buckles .....	21
Figure 30 SDLT Bent-In Leader Buckles.....	21

---

# 1 Revisions and Ownership Information

## *Revision History*

<u>Rev.</u>	<u>Date</u>	<u>Distribution</u>	<u>Major Changes</u>
0.1	10/22/04	Dell	Original version
2.1	02/07/2005	Dell	Formatted Figures and added SDLT Media handling section.
2.2	09/22/2005	Dell	Changed DLTIV Damaged section pictures, added new text to DLTIV Drives and Media section
2.3	10/10/2005	Dell	Created new Media Labeling section. Updated part numbers.

---

## 2 Introduction

This document describes the media compatibility, handling and usage for the Dell™ PowerVault™ 110T DLT, SDLT 320/220, DLT1/VS80 and VS160. Table 1 shows the basic characteristics of the drives.

This document does not cover DAT72, DDS4, LTO, LTO2, and LTO3 Tape technologies.

### 3 Drives and Media





					
	<i>Figure 1 DLT1</i>	<i>Figure 2 VS80</i>	<i>Figure 3 VS160</i>	<i>Figure 4 SDLT220</i>	<i>Figure 5 SDLT320</i>
<b>Capacity (native/compressed)</b>	40GB/80GB	40GB/80GB	80GB/160GB	110GB/220GB	160GB/320GB
<b>Native Speed</b>	10.8GB/hr	10.8 GB/hr	28.8GB/hr	39GB/hr	57GB/hr
<b>Primary Media</b>	DLT Type IV	DLT Type IV	VS1 Tape	SDLTtape I	SDLTtape I

Table 1 DLT Drive Types and Basic Characteristics



			
	<i>Figure 6 Type IV Media</i>	<i>Figure 7 VS1 Media</i>	<i>Figure 8 SDLT Media</i>
<b>Part No.</b>	<b>9W080</b>	<b>P5639</b>	<b>9W085</b>
<b>DLT4000</b>	Primary	NO	NO
<b>DLT7000</b>	Primary	NO	NO
<b>DLT8000</b>	Primary	NO	NO
<b>DLT1</b>	Primary	NO	NO
<b>VS80</b>	Primary	NO	NO
<b>VS160</b>	Read only <sup>1</sup>	Primary	NO
<b>SDLT220</b>	Read only	NO	Primary
<b>SDLT320</b>	Read only	NO	Primary

Table 2 Primary Media Type per Drive

<sup>1</sup>Can only read media if it was formatted with a VS80 or DLT1 drive.



**Invalid Media Symptoms** - what happens when the wrong media is inserted into a drive

- Cleaning light comes on
- Media light flashes or stays on
- Tape ejects

## ***Reusing Type IV Media Formatted by DLT7000 or DLT8000 in VS80/DLT1 Drives***

- By default, Type IV media previously recorded by a DLT7000 or DLT8000 is not read compatible with DLT4000, DLT1, or VS80 drives
- Cartridge automatically ejects from the DLT1 and VS80 drive
- VS80/DLT1 drives can read Type IV media originally formatted in DLT7000 and DLT8000 drives only if drive compression was set to 20GB. A tape formatted in 20GB mode appears as a write-protected tape and is not writeable in a DLT1/VS80 drive. It is, however, readable. Otherwise media will continuously be ejected from the DTL1 and VS80 drive.
- Bulk Erasing (degaussing) Type IV media previously used in other drives results in what the drive sees as new media and is usable in DLT1/VS80 drives.

## ***DLT1 and VS80 Drives***

- Uses only Type IV media for read and write

## ***VS160 Drives***

- Uses VS1 Media for read and write
- Can read Type IV media only if media was formatted by DLT1 or VS80 drive NOT DLT4000/7000/8000.
- Cannot write to Type IV media
- If blank Type IV media is inserted, the media light flashes and media ejects from the drive

## ***SDLT320 and SDLT220 Drives***

- Uses SDLT type media for read and write
- Can backward read all Type IV media written with DLT (DLT4000, DLT7000, DLT8000, DLT1 and VS80) drives
- SDLT320 can read media created with the SDLT220; the 220 media light will come on
- SDLT220 cannot read media created by SDLT320; drive gives no warning but backup software indicates bad media.
- Always label media with original use and formatting information

	Read by DLT4000	Read by DLT7000	Read by DLT8000	Read by DLT1	Read by VS80	Read by VS160	Read by SDLT220	Read by SDLT320
<b>New Unformatted Type IV Media</b>	YES	YES	YES	YES	YES	NO <sub>2</sub>	NO <sub>6</sub>	NO <sub>6</sub>
<b>Type IV Written by DLT4000</b>	YES	YES	YES	YES	YES	NO <sub>2</sub>	YES <sub>1</sub>	YES
<b>Type IV Written by DLT7000</b>	* NO	YES	YES	* NO <sub>2</sub>	* NO <sub>2</sub>	NO <sub>2</sub>	YES <sub>1</sub>	YES
<b>Type IV Written by DLT8000</b>	* NO	* NO	YES	* NO <sub>2</sub>	* NO <sub>2</sub>	NO <sub>2</sub>	YES <sub>1</sub>	YES
<b>Type IV Written by DLT1</b>	NO	NO	NO	YES	YES	YES <sub>1</sub>	YES <sub>1</sub>	YES
<b>Type IV written by VS80</b>	NO	NO	NO	YES	YES	YES <sub>1</sub>	YES <sub>1</sub>	YES
<b>VS1 written by VS160</b>	NO	NO	NO	NO	NO	YES	NO	NO
<b>SDLT1 written by SDLT220</b>	NO	NO	NO	NO <sub>3</sub>	NO <sub>3</sub>	NO <sub>2</sub>	YES	YES <sub>5</sub>
<b>SDLT1 written by SDLT320</b>	NO	NO	NO	NO <sub>3</sub>	NO <sub>3</sub>	NO <sub>2</sub>	** NO <sub>4</sub>	YES

Table 3 Type IV, VS1, and SDLT1 Media Read/Write Compatibility

- Drives in BLUE read and write Type IV media only. See chart for format limitations.
- Drives in GREEN read and write SDLT media. They can also read Type IV media.
- Drives in RED read and write VS1 media. They can also read Type IV media written by VS or DLT1 drives.

- 1 - Orange alert/media light comes on.
- 2 - The orange alert/media light illuminates and the tape automatically ejects. The alert/media light goes off if readable media is inserted into the drive or power is cycled on the drive.
- 3 - No lights come on. The drive automatically ejects the tape
- 4 - No lights come on. Backup software shows bad media.
- 5 - Orange (220) LED blinks indicating that a 220-formatted tape is in the drive.
- 6 - No lights blink. The tape does not eject. There is no indicator on the SDLT that indicates no data on tape.

\* Under default settings the DLT7000 and DLT8000 write to tape in their default density; 70GB 2:1 compressed and 80GB 2:1 compressed respectively. Tapes written by DLT7000/8000 devices will be read-only in DLT4000, DLT1, and VS80 if density 20.0 is selected on the front panel of the drive prior to writing to the tape media.

\*\* Density selection is not mechanically available on the front panel of SDLT drives. However, for backward compatibility reasons, an SDLT320 Density Select Utility is available on Quantum's website in the SDLT320 download area. This software utility allows an SDLT320 drive to write in an SDLT220 format. The utility is available for both Windows® and Linux platforms.

## 4 Cleaning Considerations

Although DLT4000/7000/8000/DLT1 and VS80 drives use the same Type IV data media, they **DO NOT** all use the same cleaning tape.

- DLT tape drives do not need periodic cleaning.
- Only clean DLT tape drives when a request is made by backup software, when a cleaning indicator is seen on the drive, or when trouble-shooting.





				
	<i>Figure 9 Cleaning Tape III</i>	<i>Figure 10 DLT/VS Cleaning Tape</i>	<i>Figure 11 VS160 Cleaning Tape</i>	<i>Figure 12 SDLT Cleaning Tape</i>
Physical Description	Typically cream colored and labeled "DLT Cleaning Tape III".	Light brown colored. May be designated DLT1 or VS80.	Light grey in color and labeled as VS160 Cleaning Cartridge.	Light gray in color and designated as SDLT Cleaning Tape.
<b>Part No.</b>	<b>Not Available</b> <small>Dell does not sell this media</small>	<b>1X021</b>	<b>X0938</b>	<b>1X025</b>
DLT4000	YES	NO	NO	NO
DLT7000	YES	NO	NO	NO
DLT8000	YES	NO	NO	NO
DLT1	NO	YES	NO	NO
VS80	NO	YES	NO	NO
VS160	NO	YES (not recommended)	YES	NO
SDLT220	NO	NO	NO	YES
SDLT320	NO	NO	NO	YES
Characteristics	<ul style="list-style-type: none"> <li>• Cleaning material inside looks like standard black media tape.</li> <li>• User must keep track of how many times this cleaning tape is used.</li> </ul>	<ul style="list-style-type: none"> <li>• Cleaning media.</li> <li>• Cleaning material is light in color and looks more like cloth than tape.</li> <li>• Tape leader is black in color and may look like electromagnetic tape.</li> <li>• User must keep track of how many times this cleaning tape is used.</li> </ul>	<ul style="list-style-type: none"> <li>• Specifically designed to clean VS160 Drives.</li> <li>• VS80/DLT1 cleaning may be used to clean a VS160 drive, but not recommended.</li> <li>• User must keep track of how many times this cleaning tape is used.</li> </ul>	<ul style="list-style-type: none"> <li>• Specifically for SDLT220 and SDLT320 drives.</li> <li>• Do not use VS160 Cleaning media to clean SDLT drives.</li> <li>• Tape can track usage. On last use, the cleaning light goes off and the drive does not eject the cartridge. User must manually eject the cartridge and discard it to prevent future use.</li> <li>• If expired cleaning media is used, the cartridge does not eject and cleaning light stays on.</li> </ul>
Lifespan	20 Uses	20 Uses	20 Uses	20 Uses
Tracking	User keeps track	User keeps track	User keeps track	Tape keeps track

Table 4 Cleaning Media Compatibility

## Exhausted Cleaning Media

If a cleaning tape is inserted into a DLT/SDLT drive and the light remains on after the tape ejects, this indicates that the cleaning tape may be exhausted. Refer to Table 5 to ensure that you are using the proper cleaning tape for your drive type. If so, try a new cleaning tape. Depending on the model drive, if the light does not extinguish when a new cleaning tape is inserted then there may be a hardware fault in the drive.

	Tape is ejected, cleaning light stays on	Tape is ejected, cleaning light goes out	Tape is not ejected, cleaning light goes out	Tape is not ejected, cleaning light does not go out
Expired cleaning cartridge in a DLT4000/DLT7000 drive	X			
Expired cleaning cartridge in a SDLT220/SDLT320 drive			On 20th (last) use	X
Expired cleaning cartridge in a DLT1/VS80 drive		X		
Expired cleaning cartridge in a VS160 drive		X		

*Table 5 Symptoms of Using Expired Cleaning Media*

**X** - With DLT1/VS80 and VS160 there is no method to determine that the cleaning tape is expired except to manually note usage on the check box label. It is the customer's responsibility to record usage of the Cleaning Tape and discard after 20 uses. The cartridge has little or no effect on head cleaning after the recommended 20 uses.

---

## 5 Media Handling

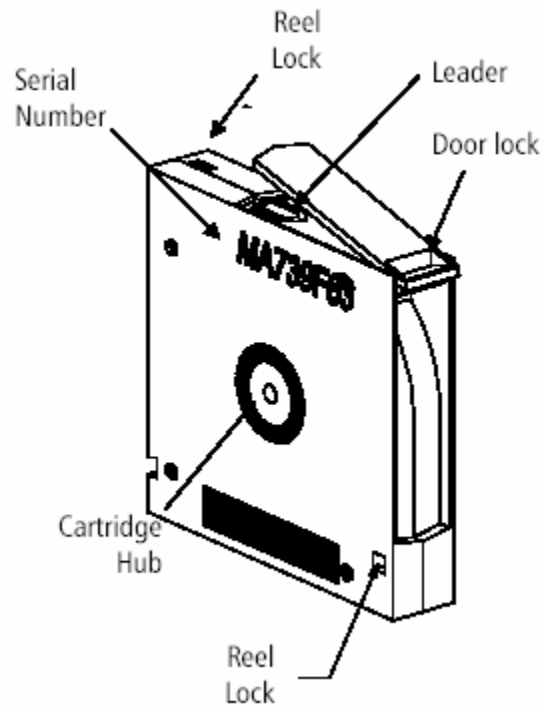

*Figure 13. Type IV Media Cartridge*

- ▶ **Cartridge Leader** – Buckles with drive leader to pull media from cartridge. Two types, DLTtape cartridges (mylar loop) and Super DLTtape cartridges (plastic buckle with metal pin).
- ▶ **Reel Locks** – Prevent the media reel in the cartridge from spinning when the cartridge is not loaded in a drive and ensures proper tension of media is maintained.
- ▶ **Cartridge Hub** – Mechanical interconnect between the cartridge and the drive reel motor.

**Write Protect Switch** – The write protect switch prevents overwrite or erasure of data. When this switch is activated (orange is visible), data cannot be written to, appended to, or overwritten on the media.

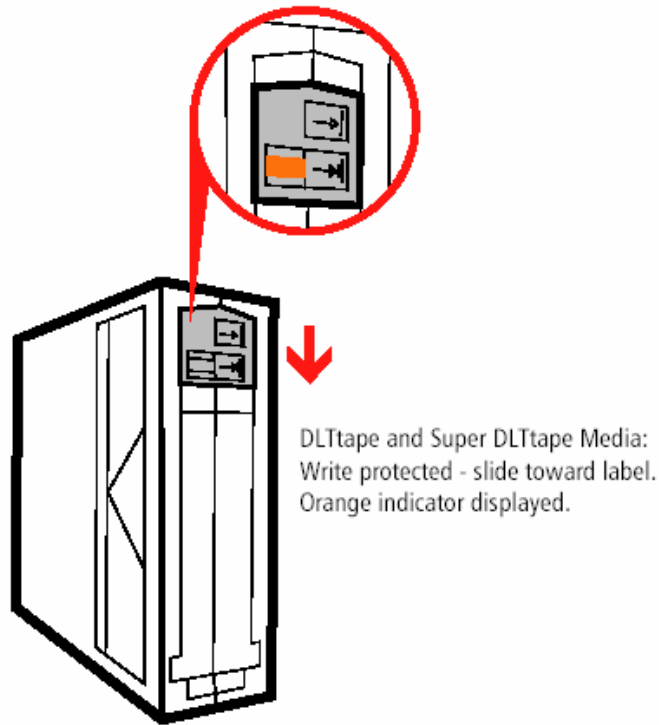

*Figure 14 Write Protect Tab*

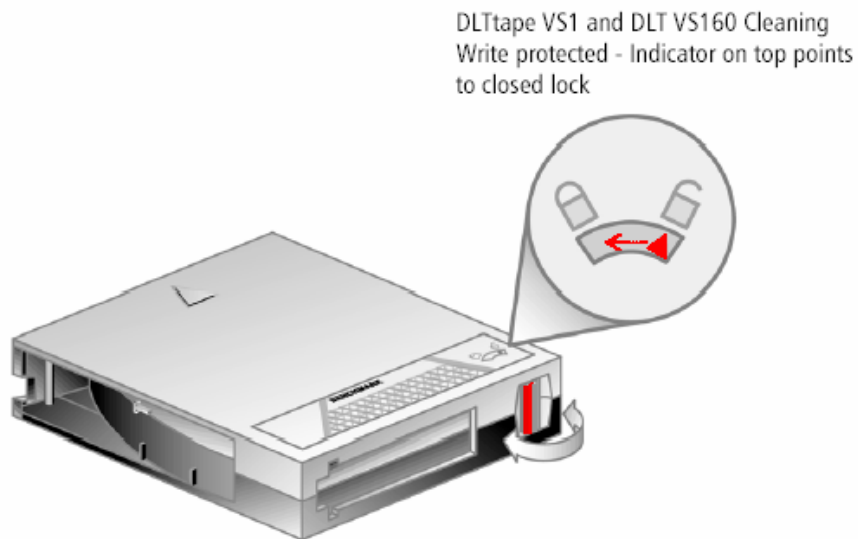

*Figure 15 VS1 Write Protect Tab*

## Media Care Guidelines

DLTtape cartridges are engineered to be reliable, robust, and durable. They are manufactured to withstand 1,000,000 passes, and have a shelf life of 30 years. For best results, follow these guidelines for media care:

- ▶ Protect cartridges from shock, vibration, moisture, and magnetic fields.
- ▶ Keep media in protective cases and store vertically when not in use.
- ▶ Use the sliding labels provided. Do not use adhesive labels or Post-it® notes, and do not write on the cartridge.
- ▶ Write in pen, not pencil. Pencils can introduce contaminants to the tape path.
- ▶ Store loose labels separately to prevent labels from accidentally covering the hub.
- ▶ Never touch the tape or tape leader. Dust and oils from your skin contaminate the tape and affect performance.
- ▶ If you drop a cartridge, perform a visual media inspection before inserting it into the drive.

**! The safety of your data relies on proper care and handling of media cartridges.**

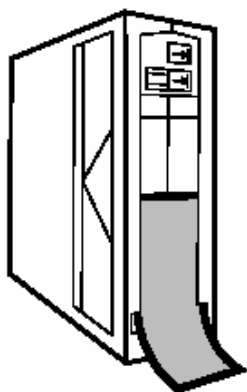

Use slide-in label

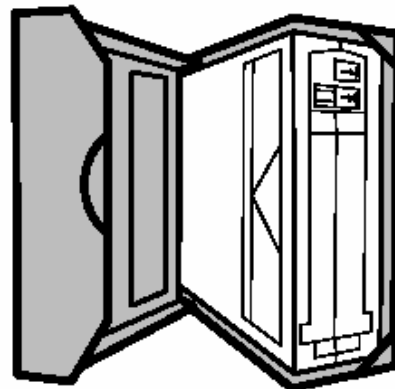

Store media vertically in protective plastic cases

*Figure 16 Media Care*

## ***Proper Media Labeling Techniques***

Every new DLTtape IV, VS1, and SDLT cartridge comes with a sheet of labels in the storage box. These are non-adhesive labels and are designed to slide into the label slot on the front of the cartridge. To decrease the chance of a tape drive failure due to improper labeling, follow these guidelines for proper application of media labels:

- ▶ Never put a label or barcode anywhere but in the front label slot (see Figure 17 and 18 below). Placing anywhere other than this label slot may result in damage to the tape drive.
- ▶ Never use adhesive-based labels on your cartridges.
- ▶ Store extra labels away from the cartridge. Labels clinging to the cartridge because of static or humidity can be introduced into the tape drive and block the cartridge drive gear.



*Figure 17 Proper Label Placement*



*Figure 18 Proper Barcode Placement*



## Visual Media Inspection

When to perform a visual inspection

- ▶ Best practices: Each time a tape is loaded or changed
- ▶ When a tape cartridge is dropped or subjected to a hard physical shock
- ▶ When a shipment of tapes shows any sign of shipping damage
- ▶ If the DLT, DLT VS or SDLT drive becomes inoperable after loading a tape

**! If a drive error occurs, inspect the current and previous cartridge used in that drive.**

To Inspect a Cartridge

- ▶ **Case:** Inspect the case for cracks, chips or signs of damage.
- ▶ **Cartridge:** Inspect the exterior of the cartridge for chips, cracks, dents, or missing screws. Gently shake the cartridge. Listen for rattling or loose pieces.
- ▶ **Cartridge door:** Ensure that the door is moveable and the spring is present.
- ▶ **Write Protect Switch:** Move switch. It should snap into write-protected mode and write-enabled mode.
- ▶ **Cartridge Leader:** Gently inspect the cartridge leader to verify that it has not been damaged and is in the correct position.
  - DLTtape cartridges: Check the height of the leader to ensure that the loop is sticking up approximately 3/16" (4mm).
  - Super DLTtape Cartridges: Ensure that the buckle is not bent in or out.

**! When inspecting the cartridge leader do not use anything that could leave contamination, such as a pen or pencil.**

- ▶ **Reel Locks:** Check that both reel locks are visible. Verify operation using a small flat-blade screwdriver. The reel locks should spring back when released.
- ▶ **Cartridge Hub:** Confirm the spring-loaded hub on the bottom of the cartridge is centered. Press the hub; it will spring back if operating properly.

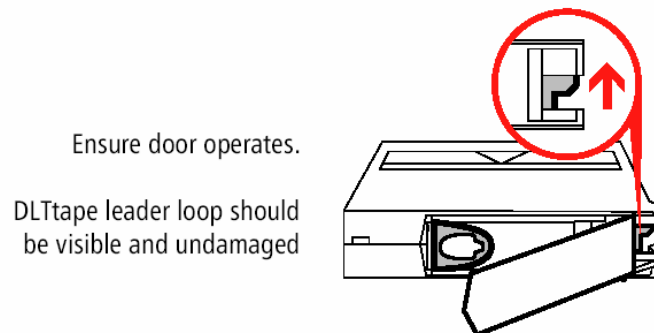

Figure 19 Media Inspection 1

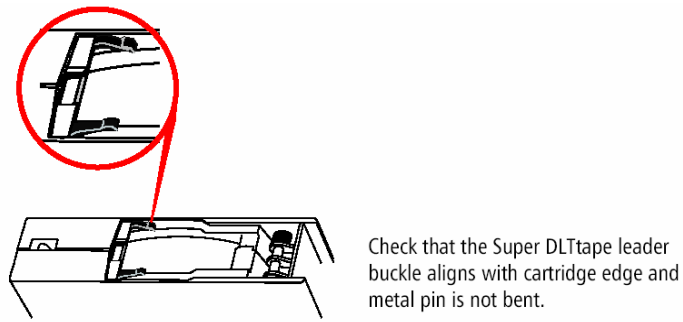

Figure 20 Media Inspection 2

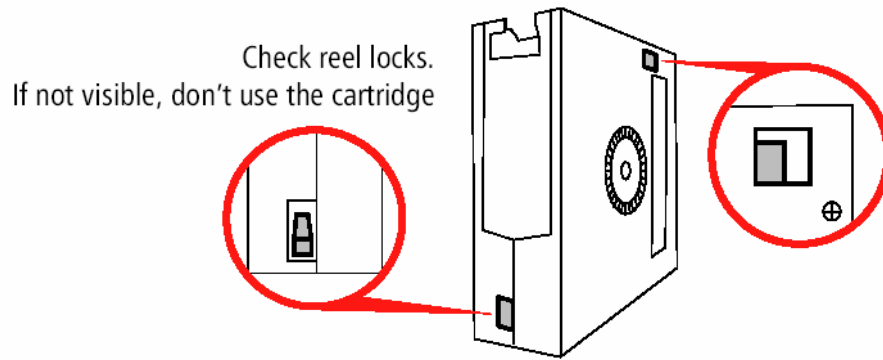

Figure 21 Media Inspection 3

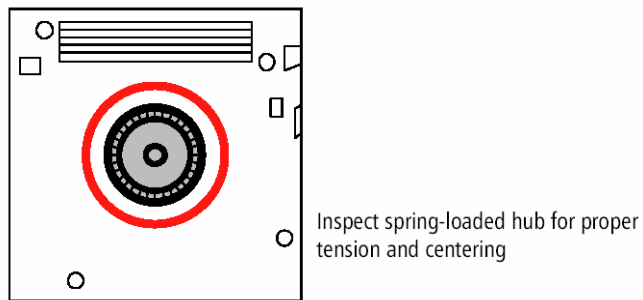
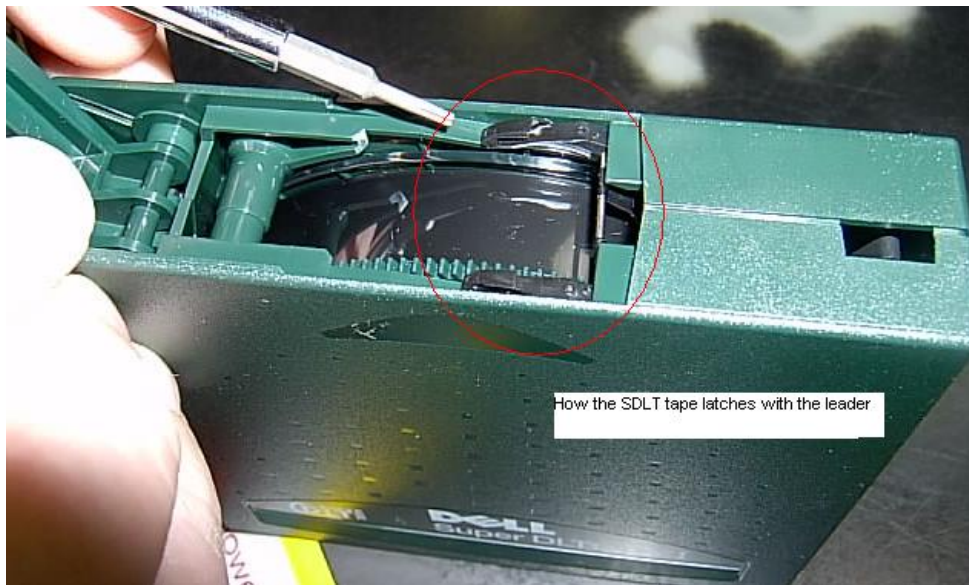
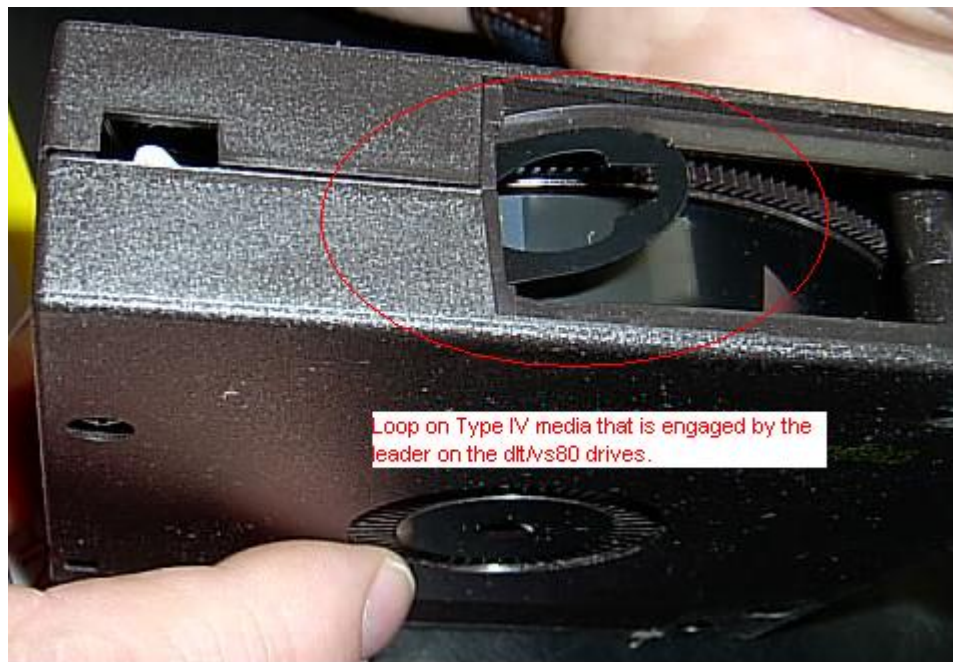

Figure 22 Media Inspection 4



*Figure 23 SDLT Leader Latch*



*Figure 24 DLT Type IV Leader Loop*

## ***DLTIV Cartridge Damage Examples***

Do not use any cartridge exhibiting the types of problems shown in these examples.

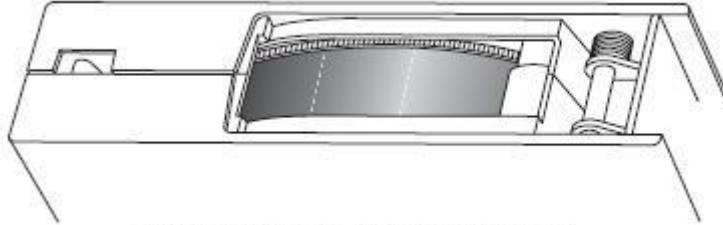

*Figure 25 Missing Cartridge Leader*

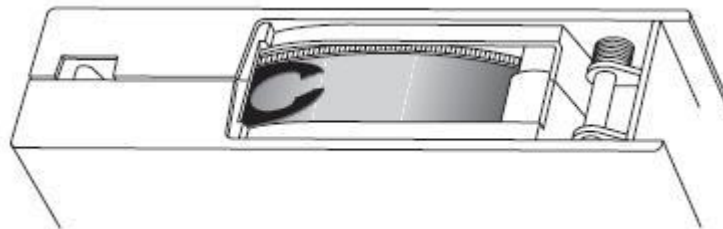

*Figure 26 Broken Leader Loop*

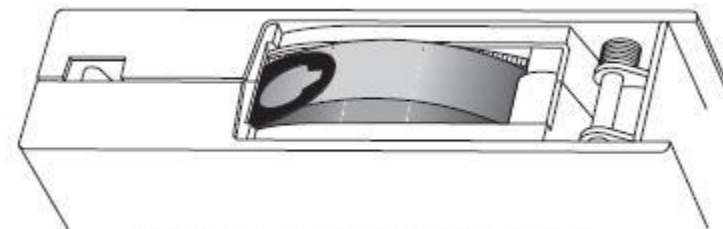

*Figure 27 Loosely Packed Media*

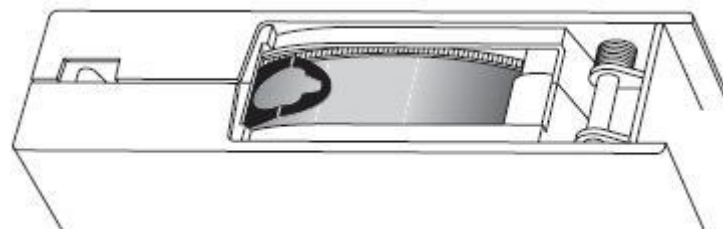

*Figure 28 Creased Leader Loop*

## SDLT Media

When inspecting an SDLT media cartridge refer to the following diagrams to check the leader buckles on the media. Figure 29 shows a good cartridge.

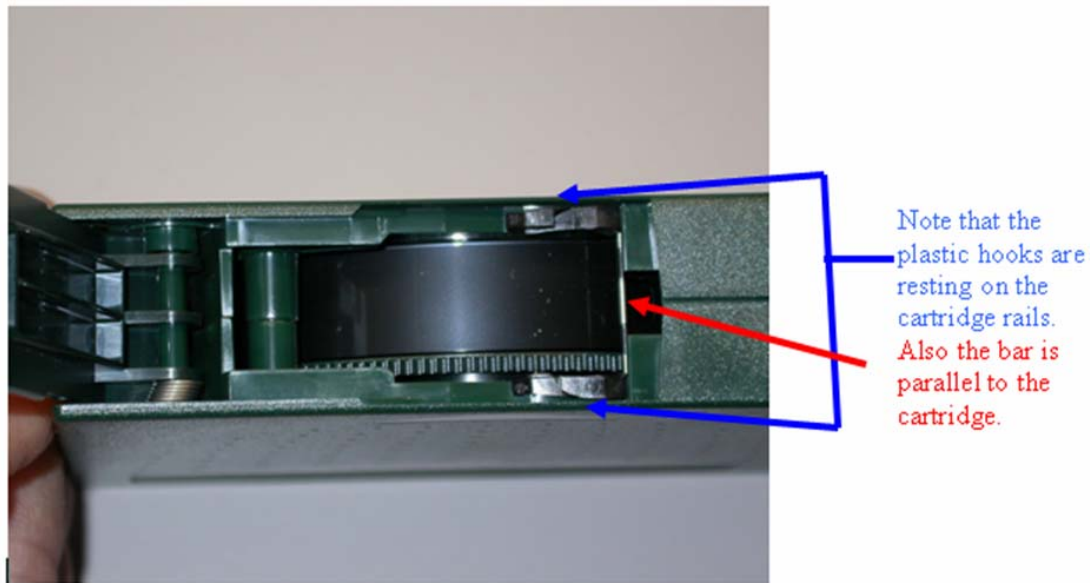

*Figure 29 Good SDLT Leader Buckles*

Tests have shown that dropping the media causes excessive stress to the spring-loaded cartridge hub. This stress can pull the tape media further into the media cartridge and bend the leader buckles. Refer to Figure 30 to identify bent-in leader buckles.

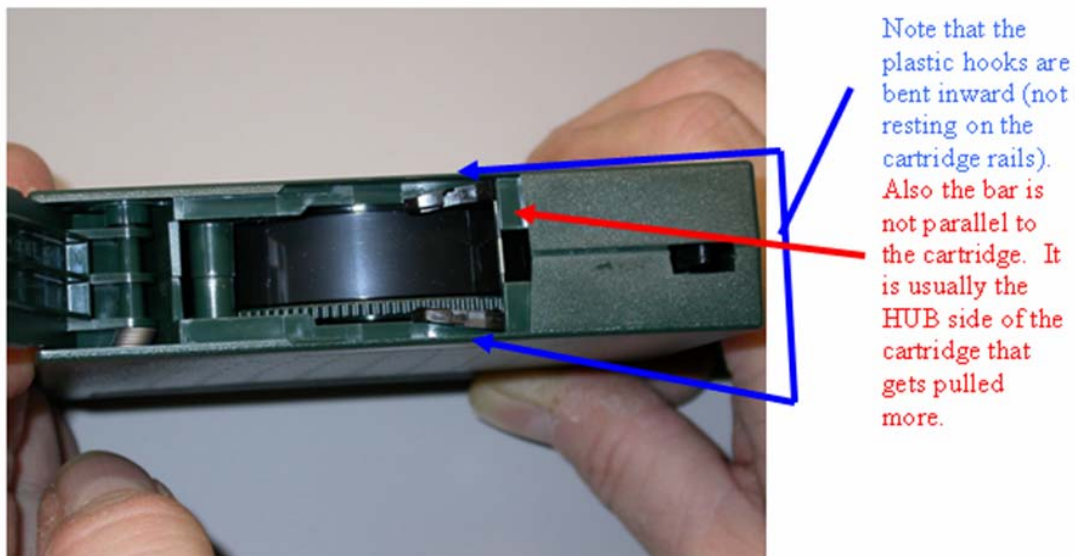

*Figure 30 SDLT Bent-In Leader Buckles*

Media with bent-in leader buckles can cause the tape drive to drop the leader when trying to load the media into the take-up reel.

## ***Cartridge Storage Conditions***

### **Avoid moisture and direct sunlight**

- ▶ Can deform cartridge and/or ruin media

### **Normal storage (non-archival)**

- ▶ Between 61° F and 90° F (16° C and 32° C)
- ▶ Between 20% and 80% relative humidity
- ▶ Maximum wet bulb temperature 78° F (26° C)

### **Data archival storage (for one or more years)**

- ▶ Between 64° F and 79° F (18° C and 26° C)
- ▶ Between 40% and 60% relative humidity

## ***Media Do's and Do Not's***

### **Do**

- ▶ Store cartridges in their protective cases
- ▶ Handle cartridges with great care
- ▶ Store cartridges vertically
- ▶ Align cartridges so the grooves interlock
- ▶ Inspect cartridges prior to each use
- ▶ Unload cartridges prior to powering down the drive
- ▶ Allow a 24-hour conditioning period before using new or stored cartridges. This allows tapes to reach the same operating temperature and humidity level as the drive.

### **Do Not**

- ▶ Touch the media or leader with bare fingers
- ▶ Use pens or pencils during cartridge inspection
- ▶ Drop cartridge
- ▶ Stack cartridges horizontally
- ▶ Disassemble cartridges
- ▶ Use adhesive labels
- ▶ Ship cartridges in drive
- ▶ Store near magnetic fields (e.g., speakers, monitors, electric motors, power supplies)
- ▶ Use a cartridge that fell from 3 ft. or higher